

MODEL 625E

PARTSLIST

MODEL 625E

PARTSLIST

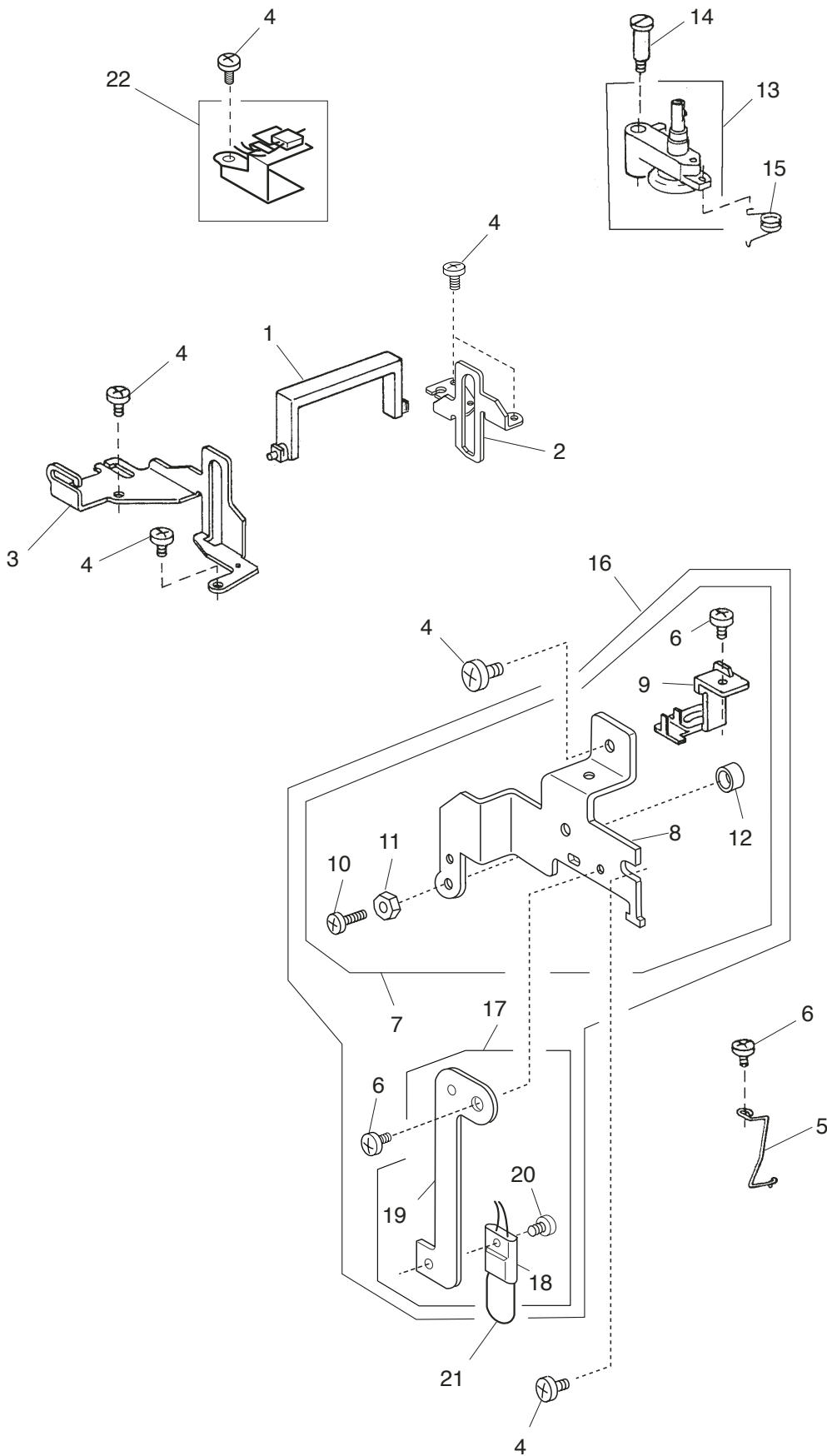

PARTSLIST

No.	Part #	Description
1	751100000	Carrying handle
2	507150002	Carrying handle supporter (right)
3	507116006	Carrying handle supporter (left)
4	000081005	Setscrew 4X8
5	652137006	Arm thread guide (2)
6	000101404	Setscrew 4X6
7	507605306	Face plateset plate (unit)
8	507161006	Face plateset plate
9	751020027	Threader shaft guide (upper)
10	000104706	Setscrew 4X16
11	000160102	Adjustable lock nut4
12	685042005	Supporter stopper
13	652506000	Bobbin winder (unit)
14	652093009	Setscrew
15	659034003	Spring
16	507652009	Face plate set plate (unit)
17	507645009	Lamp socket (unit)
18	501509105	Lamp socket (unit)
19	507127000	Lamp set plate
20	000102900	Setscrew 2X8
21	000026002	Wedge base lamp 12V5W
22	751592014	Switch base plate (unit)

PARTSLIST

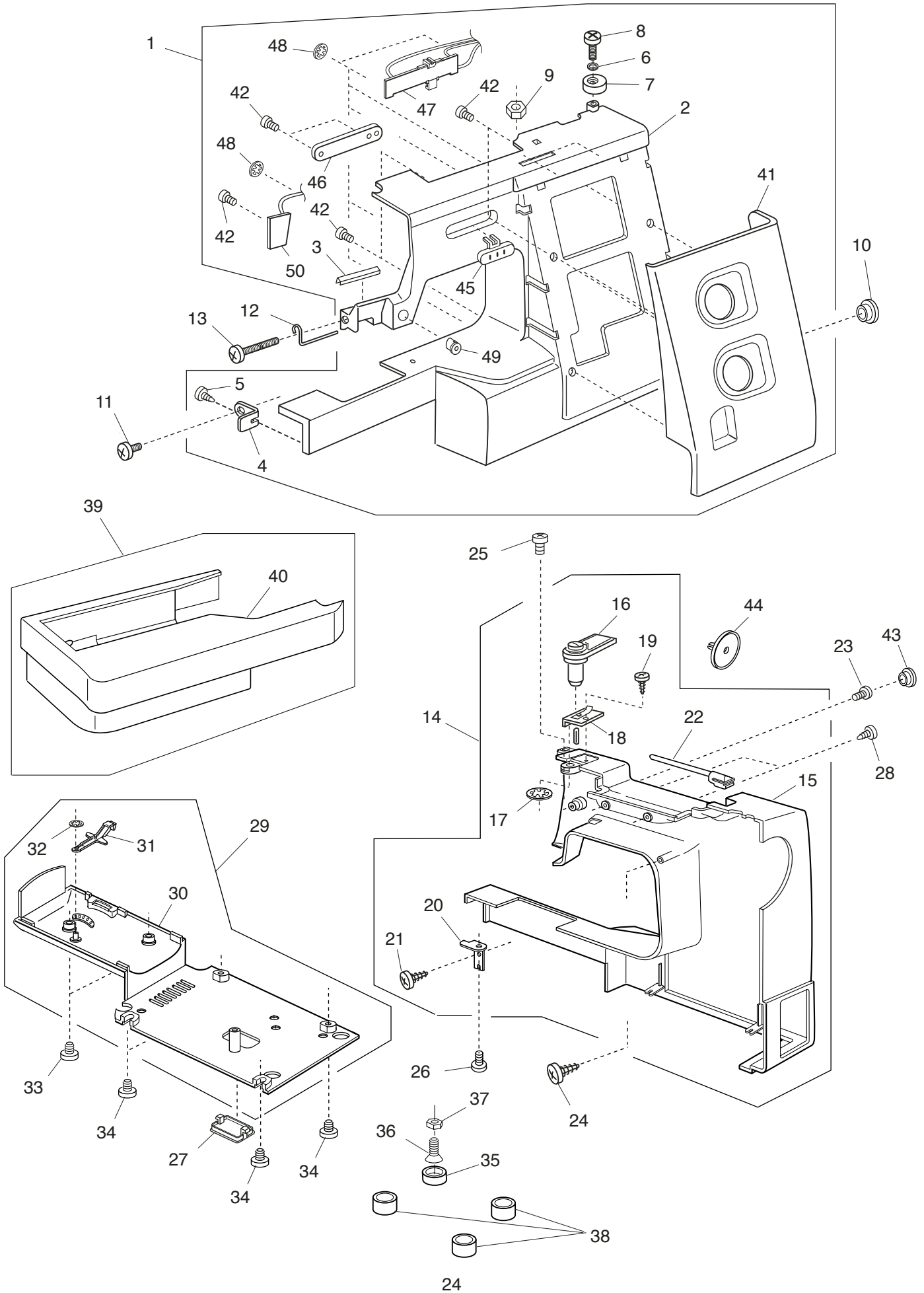

PARTSLIST

No.	Part #	Description
1	507617002	Front cover (unit)
2	507110505	Front cover
3	753125007	Thread guide
4	827069004	Front cover set plate (lower)
5	000120203	Setscrew 3X8
6	000071013	Washer 4
7	735016307	Bobbin winder stopper
8	000103107	Setscrew 4X14
9	000061205	Nut 4-3-7
10	745033002	Cap
11	000101404	Setscrew 4X6
12	753126008	Arm thread guide
13	000092917	Setscrew 3.5X27
14	507631002	Rear cover (unit)
15	507102102	Rear cover
16	650503702	Thread guide (unit)
17	000014409	Snap ring CS8
18	827503005	Top cover thread guide (unit)
19	000162001	Setscrew 2.6X5(B)
20	827006003	Rear cover set plate
21	000161103	Setscrew 3X6(B)
22	659067005	Additional spool pin
23	000101817	Setscrew 4X16
24	000121905	Setscrew 4X12(B)
25	810220003	Setscrew
26	000081119	Setscrew 4X6
27	507115005	Cap
28	000161310	Setscrew 3X12(B)
29	507601106	Base cover (unit)
30	507001203	Base cover
31	753005000	Drop feed lever
32	000013903	Snap ring CS5
33	000101703	Setscrew 4X12
34	000103509	Setscrew 4X10
35	735002001	Rubber foot
36	000097808	Setscrew 5X25
37	000061412	Nut 5-3-8
38	647009002	Bed rubber cushion
39	507637008	Extension table (unit)
40	507503004	Extension table (unit)
41	507111171	Ornamental panel
42	000161402	Setscrew 2.3X8(B)
43	653006101	Cap
44	822020503	Spool holder (large)
45	507117007	Speed adjusting dial
46	507118008	Slide volume knob
47	653507233	Slide volume (unit)
48	000014306	Snap ring CS3
49	507119102	U/D Button
50	501504007	Printed circuit board F (unit)

PARTSLIST

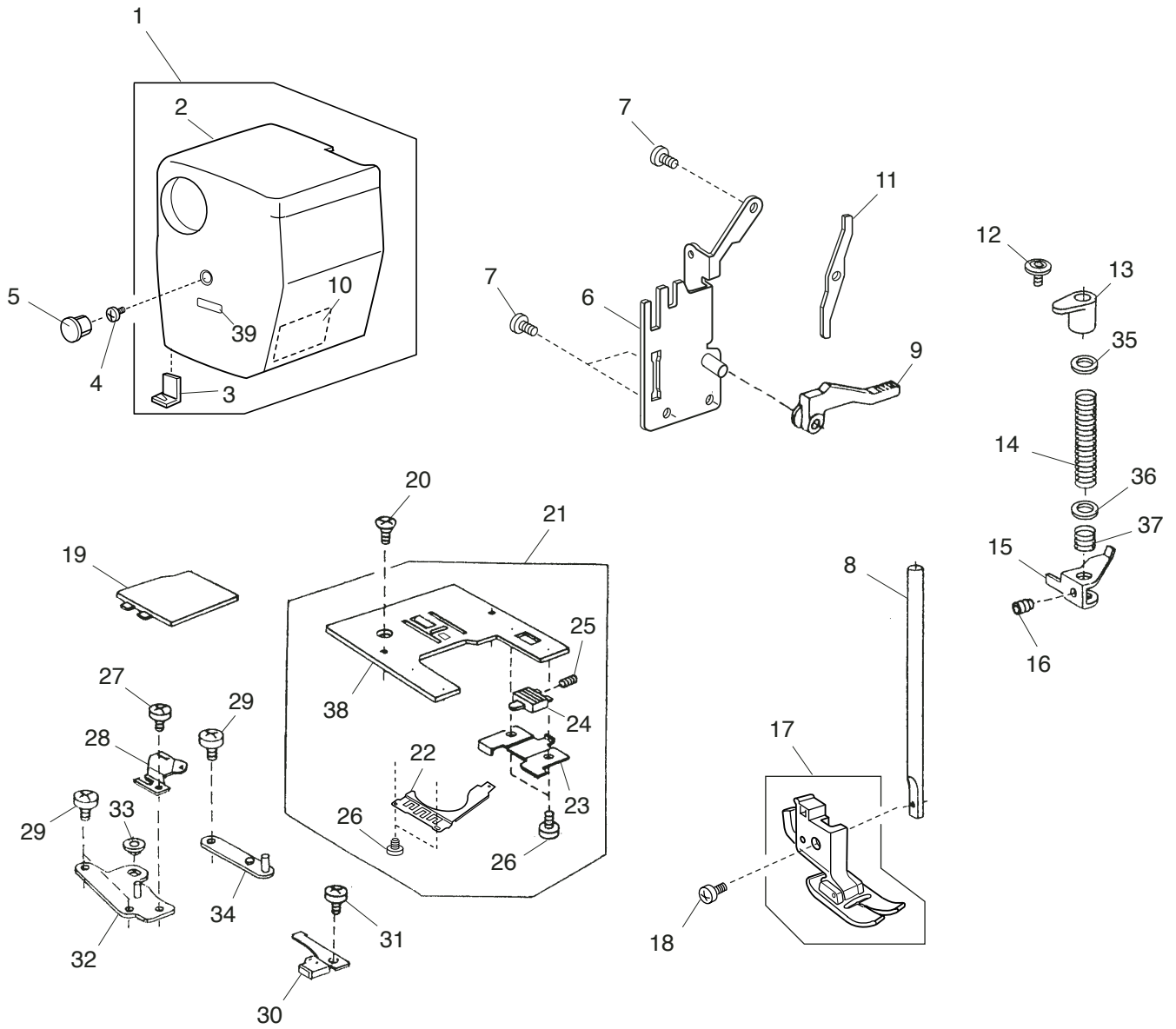

PARTSLIST

No.	Part #	Description
1	507632601	Face plate (unit)(U.S.A., Australia, UK & Continental Europe)
	507632612	Face plate (unit)(Canada)
2	507105415	Face plate
3	840602006	Thread cutter (unit)
4	000101703	Setscrew 4X12
5	653006101	Cap
6	507156008	Presser bar base plate
7	000081005	Setscrew 4X8
8	507086006	Presser bar
9	735029004	Presser foot lifter
10	724025006	Reflecting sticker(2)
11	751142004	Thread tension release lever
12	000193001	Thin-head setscrew TP 4X6
13	652104004	Presser bar bushing
14	826006000	Presser bar spring
15	735028003	Presser bar supporter
16	000111500	Hexagonal socket screw 4X8
17	660508007	Presser foot (unit)
18	660106001	Thumb screw
19	750036012	Hook cover plate
20	820390109	Needle plateSetscrew
21	751603400	Needle plate (unit)
22	832235010	Hook cover plate supporter (left)
23	825015010	Hook cover plate supporter (right)
24	825016000	Hook cover plate release button
25	825017001	Spring
26	820374004	Setscrew 2X2.3
27	000103808	Setscrew 3X5
28	822011109	Bobbin holder stopper
29	000066705	Setscrew 3X8
30	751502006	Bobbin holder stopper (unit)
31	810220003	Setscrew
32	751008007	Needle plate adjusting plate (left)
33	822314002	Nut
34	751009008	Needle plate adjusting plate (right)
35	652201002	Washer
36	826055004	Washer
37	826056005	Presser foot support spring
38	653179003	Needle plate
39	100517008	Sticker(Canada)

PARTSLIST

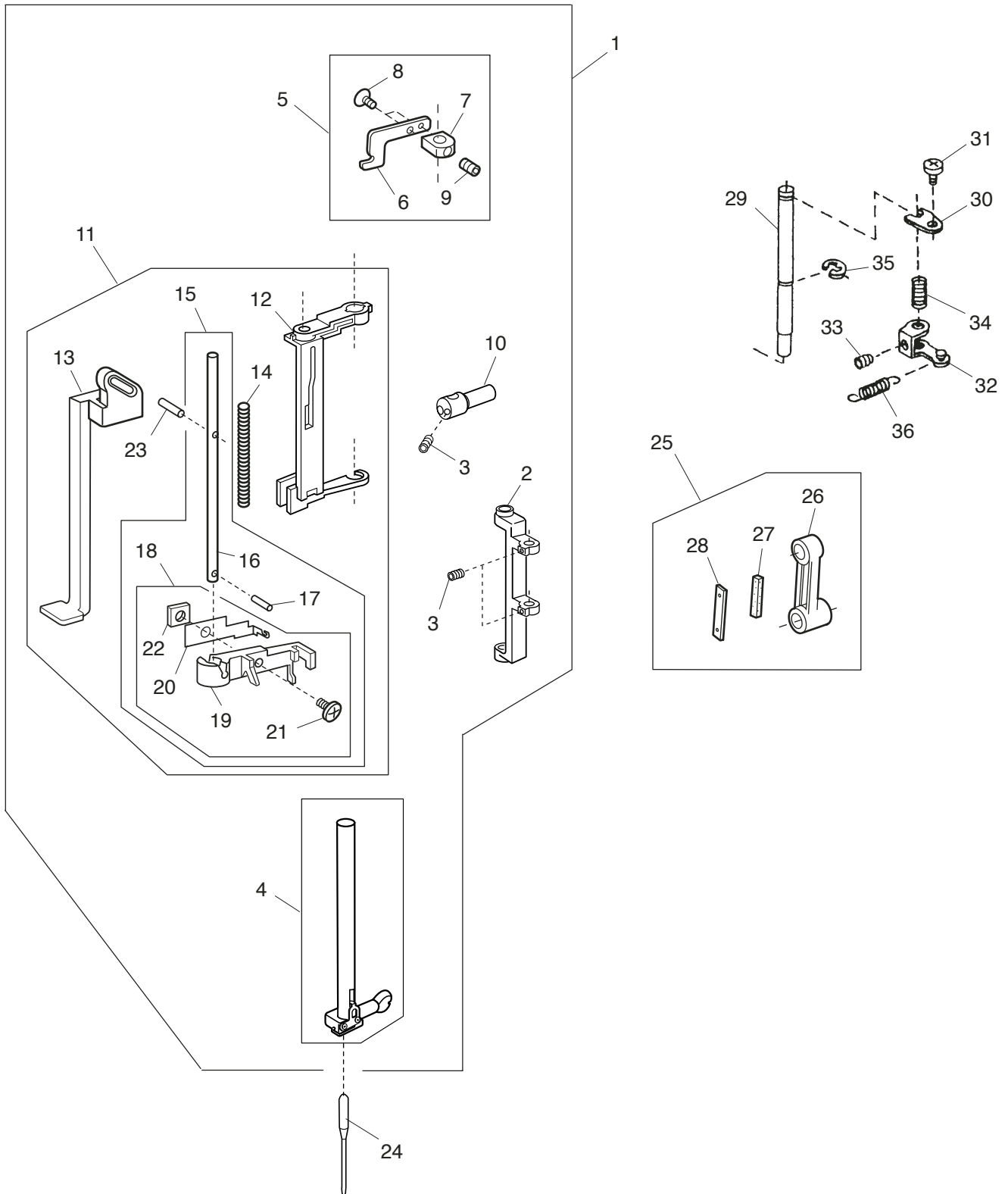

PARTSLIST

No.	Part #	Description
1	755627103	Needle bar supporter (unit)
2	751014006	Needle bar supporter
3	000111201	Hexagonal socket screw 4X4
4	751630015	Needle bar (unit)
5	751607002	Threader positioning setting plate (unit)
6	734101008	Threader positioning setting plate
7	751016008	Threader positioning setting block
8	000097602	Setscrew 2X4
9	000111902	Hexagonal socket screw 3X4
10	751047008	Needle bar connecting stud
11	853509002	Needle threader (unit)
12	755062001	Threader frame
13	853026000	Threader lever
14	755067006	Needle threader spring
15	755625008	Threader shaft (unit)
16	755066005	Threader shaft
17	000003508	Knock pin 2X8
18	755643002	Threader plate (unit)
19	755064003	Threader guard plate
20	755065004	Threader plate
21	755096004	Setscrew
22	755095003	Nut
23	000125105	PinE 2X16-CH
24	102408089	NeedleHA-14
25	650607006	Needle bar crank rod (unit)
26	650039001	Needle bar crank rod
27	650040005	Felt
28	650041006	Spring
29	650033005	Supporter shaft
30	650034006	Supporter shaft stopper plate
31	000101404	Setscrew 4X6
32	650035007	Zigzag width arm
33	000111108	Hexagonal socket screw 4X6
34	650036008	Spring
35	000001609	Snap ring E5
36	507094007	Needle bar supporter spring

PARTSLIST

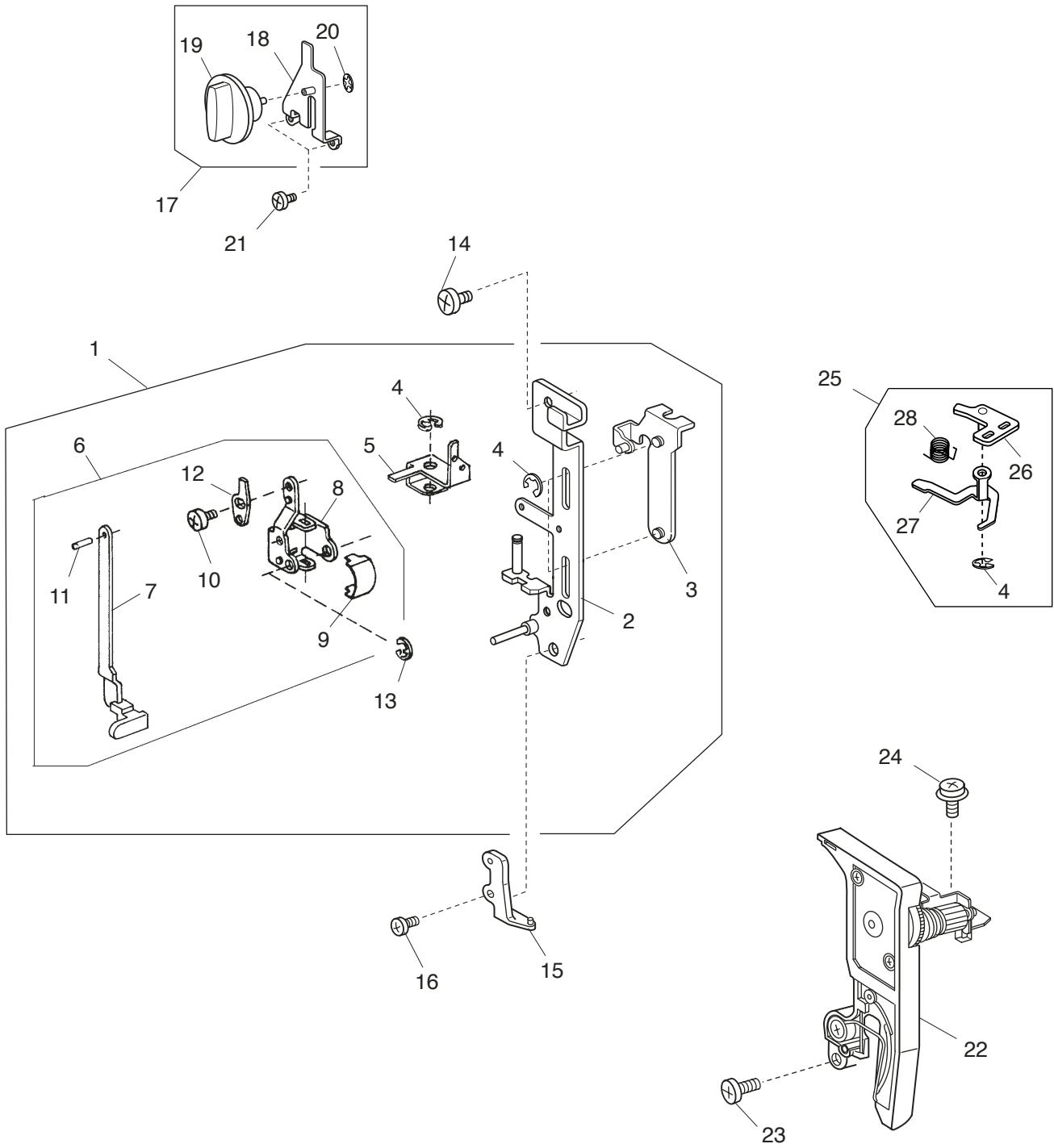

PARTSLIST

No.	Part #	Description
1	507606008	Front bracket (unit)
2	507007014	Front bracket
3	501009007	Presser foot pressure adjusting plate
4	000002105	Snap ring E3
5	751022007	Drag rod link
6	751657007	Buttonhole lever (unit)
7	751610008	Buttonhole lever (unit)
8	753026203	Buttonhole lever supporter plate
9	753027008	Spring
10	652203004	Setscrew 3x3.5
11	000023009	Knock pin 1.6X4
12	753029000	Buttonhole lever adjusting plate
13	000001207	Snap ring E2.5
14	000081005	Setscrew 4X8
15	755074006	Threader guide plate
16	000103509	Setscrew 4X10
17	507607009	Presser foot pressure dial (unit)
18	501008109	Dial set plate
19	507008004	Presser foot pressure dial
20	000014007	Snap ring CS4
21	000106203	Setscrew 3.5X4
22	507515009	Thread tension (unit)
23	000101703	Setscrew 4X12
24	000115205	Setscrew TP 4X6
25	507638009	Thread tension release arm (unit)
26	752055002	Thread tension release arm base
27	751215009	Thread tension release arm
28	752056003	Thread tension release spring

PARTSLIST

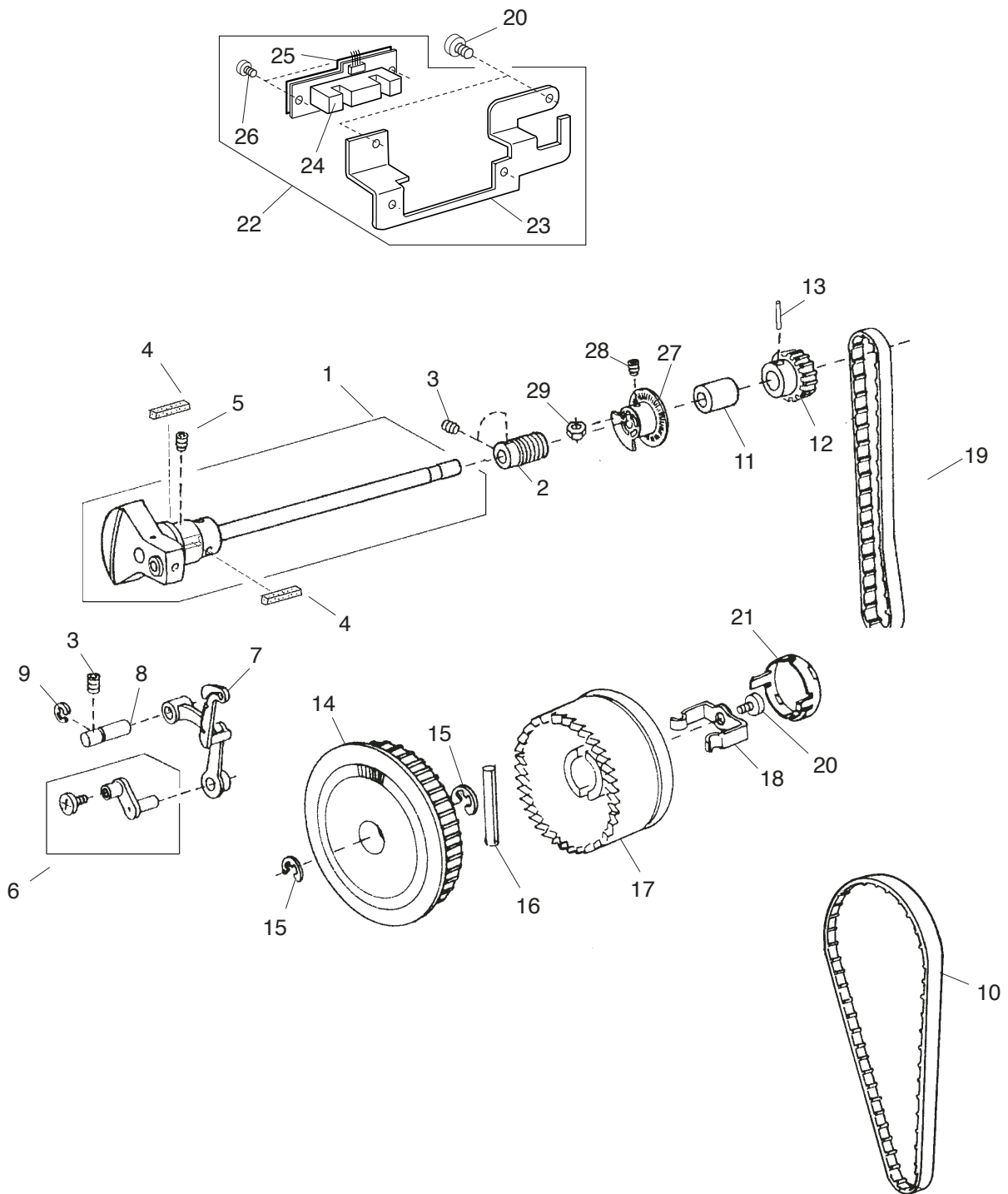

PARTSLIST

No.	Part #	Description
1	756504003	Upper shaft (unit)
2	507059000	Worm
3	000111201	Hexagonal socket screw 4X4
4	731384008	Felt
5	000111304	Hexagonal socket screw 5X5
6	652512009	Needle bar crank pin (unit)
7	820511108	Thread take-up lever (unit)
8	650062003	Thread take-up lever pin
9	000002806	Snap ring E6
10	653139012	Timing belt
11	673062004	Upper shaft rear bushing
12	756017004	Upper shaft gear
13	000020501	Knock pin 3X22
14	756018005	Belt wheel
15	000030205	Snap ring E8
16	000023803	Knock pin 4X40
17	639097024	Handwheel
18	639113016	Clutch spring
19	650071005	Timing belt
20	000081005	Setscrew 4X8
21	650070509	Handwheel cover
22	507649003	Upper shaft sensor (unit)
23	507143002	Sensorset plate
24	507509000	Printed circuit board N (unit)
25	507148007	Insulation paper
26	000101105	Setscrew 3X4
27	753133101	Upper shaft shielding plate
28	000111108	Hexagonal socket screw 4X6
29	000062402	Nut

PARTSLIST

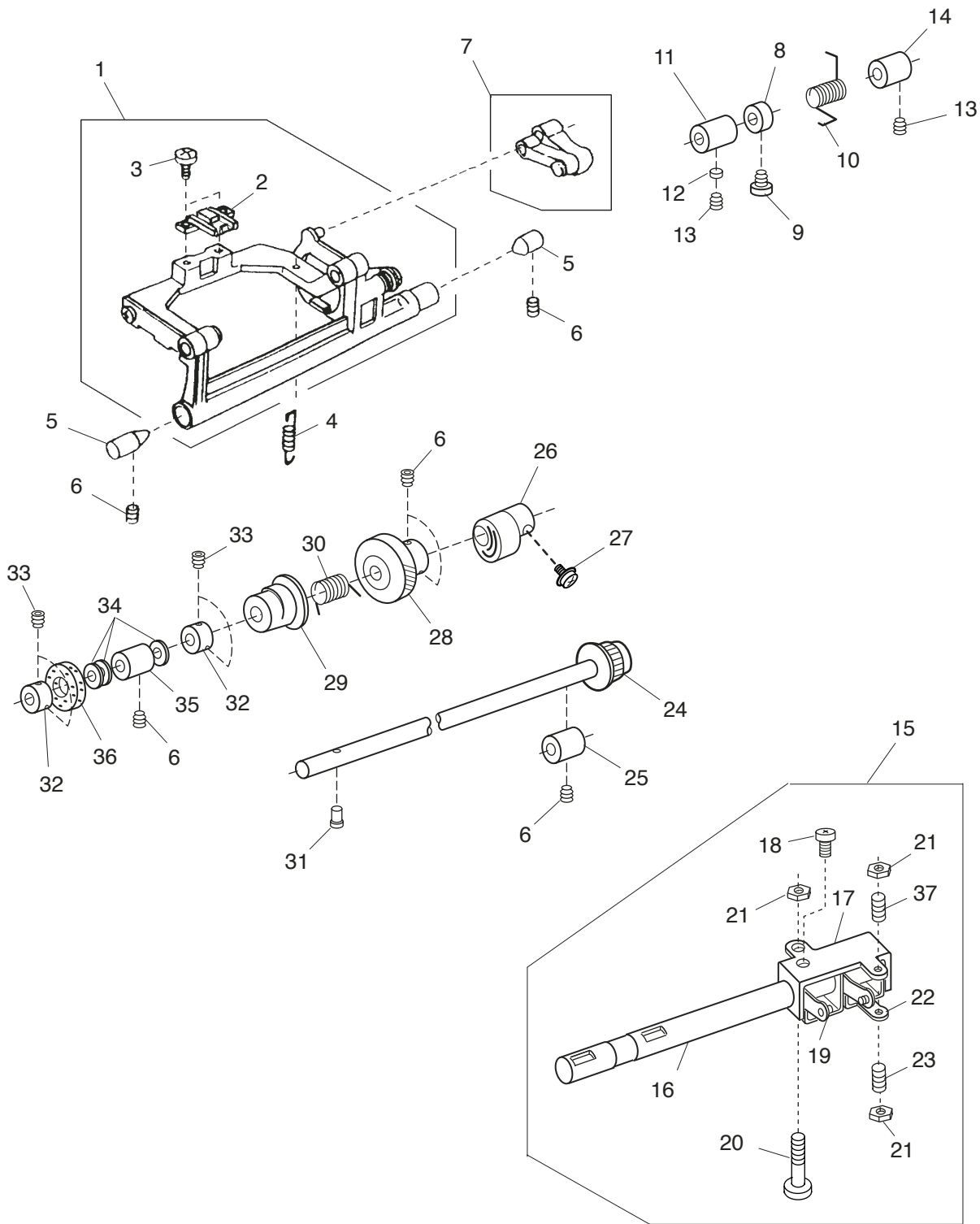

PARTSLIST

No.	Part #	Description
1	751666009	Feed lock shaft (unit)
2	653193003	Feed dog
3	000104005	Setscrew 3.5X8
4	650085002	Feed base spring
5	738055008	Straight pin
6	000111304	Hexagonal socket screw 5X5
7	650612004	Feed regulator (unit)
8	820387000	Ring
9	000081005	Setscrew 4X8
10	507095008	Feed regulator spring
11	625144002	Feed shaft bushing (front)
12	650175000	Cushion
13	000111108	Hexagonal socket screw 4X6
14	650092002	Feed shaft bushing (rear)
15	507653000	Feed regulating plate (unit)
16	507151003	Feed shaft
17	507152004	Feed shaft set plate
18	000081500	Setscrew 3X12
19	507154006	SS adjusting plate
20	000097200	Setscrew 4X12
21	000160102	Adjustable lock nut4
22	507153005	Feed regulating plate
23	648010009	Setscrew
24	751612206	Lower shaft (unit)
25	650079003	Lower shaft bushing (rear)
26	751148000	Feed cam
27	000115009	Setscrew TP 3X8
28	650076000	Lower shaft gear
29	753183025	Feed lifting cam
30	686035008	Feed lifting cam spring
31	820161006	Feed lifting pin
32	820166001	Lower shaft ring
33	000111201	Hexagonal socket screw 4X4
34	000038502	Washer ø8X0.5
35	650078002	Lower shaft bushing (front)
36	735143005	Felt
37	000159201	Setscrew 4X12

PARTSLIST

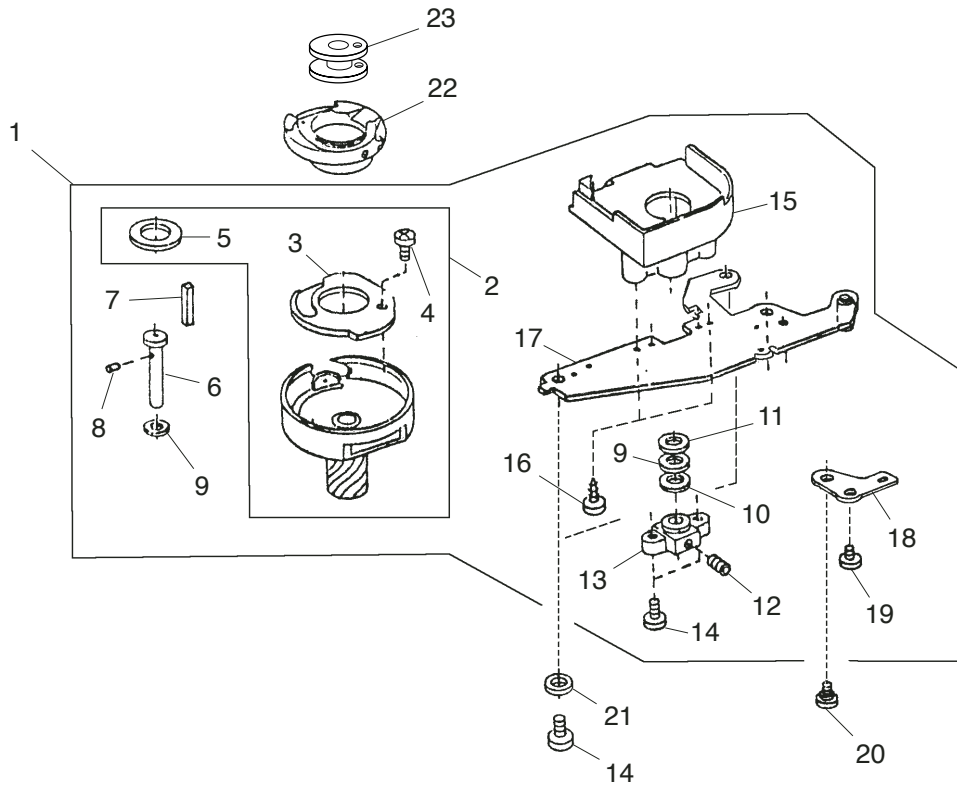

PARTSLIST

No.	Part #	Description
1	827614022	Hook race (unit)
2	652623004	Hook body (unit)
3	627191000	Hook bottom plate
4	820374004	Setscrew 2X2.3
5	627190010	Magnet
6	820123006	Hook race shaft
7	820124007	Oil string(1)
8	820125008	Oil string(2)
9	000038409	Washer $\varnothing 6 \times 0.5$
10	625102008	Washer
11	627192001	Hook race shaft washer
12	000111304	Hexagonal socket screw 5X5
13	650094004	Hook race shaft base
14	000081005	Setscrew 4X8
15	827040009	Cover
16	000107204	Setscrew 3X12(B)
17	823106002	Hook race set plate
18	650171006	Position set plate
19	000101404	Setscrew 4X6
20	650172007	Setscrew
21	000070506	Washer 4
22	627569209	Bobbin holder (unit)
23	102261000	Bobbin

PARTSLIST

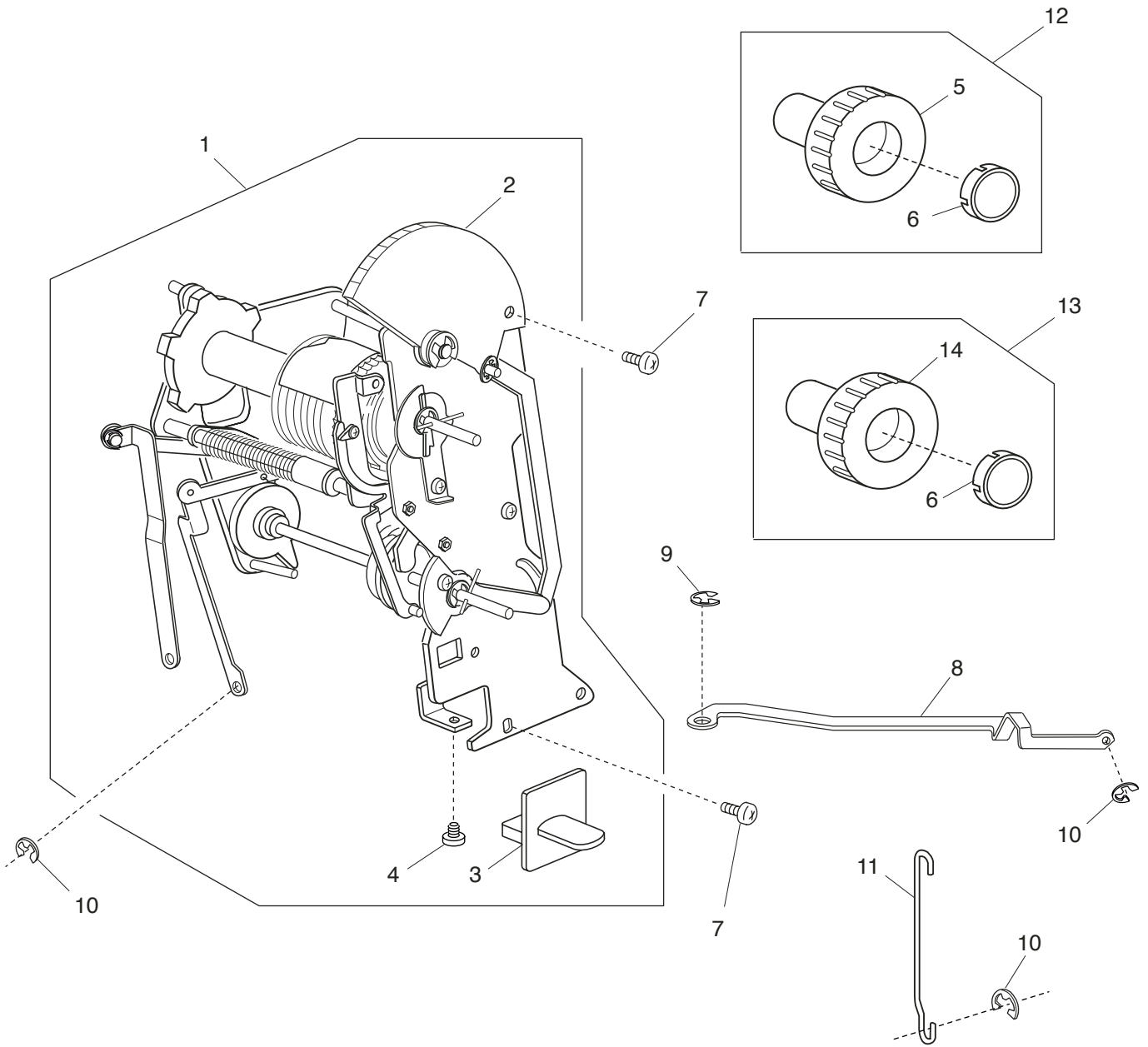

PARTSLIST

No.	Part #	Description
1	507636203	Cam block (unit)
2	507041205	Zigzag width dial
3	507109109	R lever
4	000107307	Setscrew 3X8(B)
5	507112242	Pattern selector dial
6	507113003	Dial cover
7	000081005	Setscrew 4X8
8	507066000	Zigzag width rod
9	000002507	Snap ring E4
10	000002105	Snap ring E3
11	507047005	BH Rod
12	507635051	Pattern selector dial (unit)
13	507635062	Feed dial (unit)
14	507112253	Feed dial

PARTSLIST

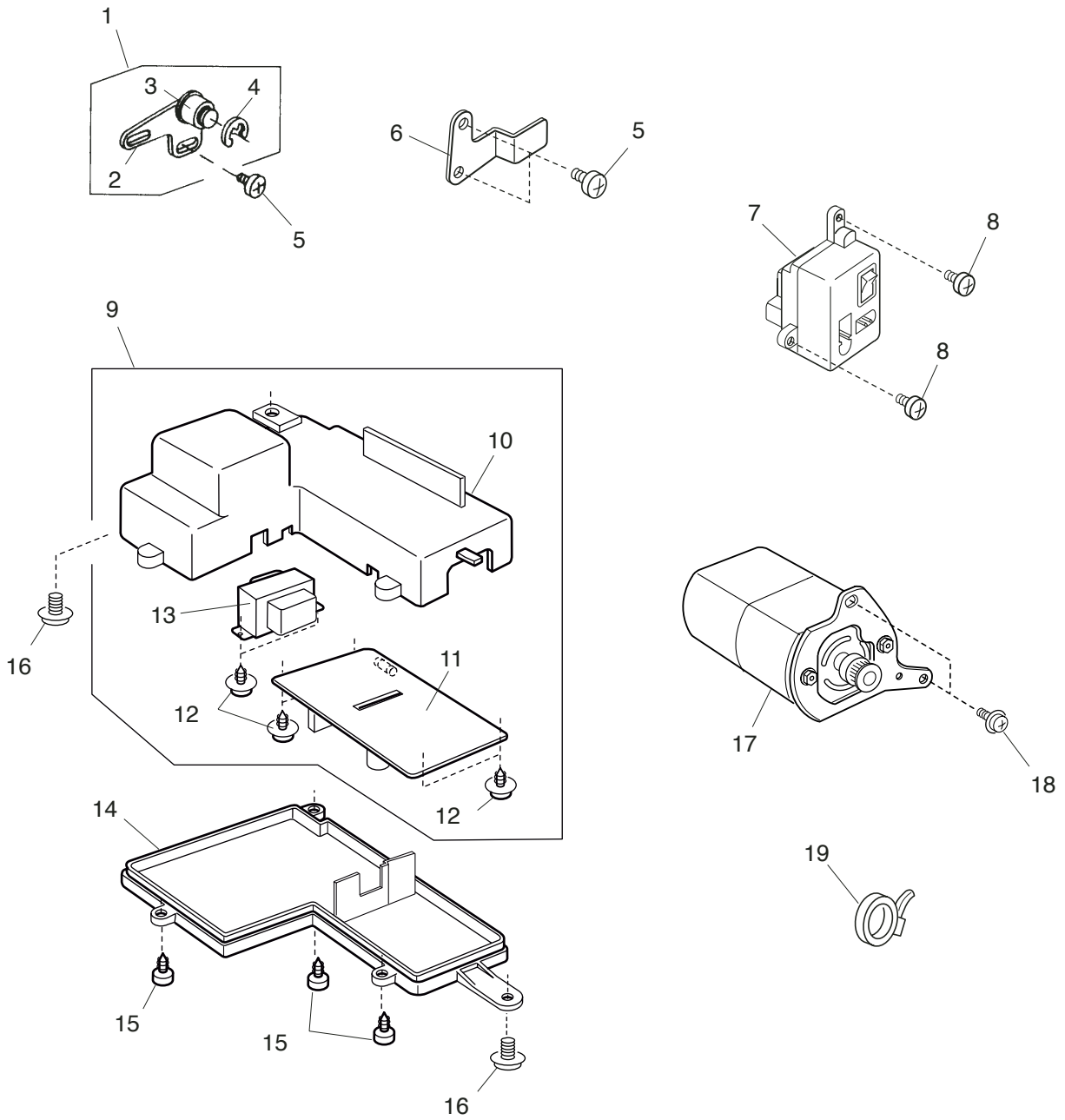

PARTSLIST

No.	Part #	Description
1	753619003	Idler (unit)
2	753119008	Idler base
3	625217100	Idler
4	000002806	Snap ring E6
5	000081005	Setscrew 4X8
6	507067001	Set plate
7	507512006	Machine socket (unit)(U.S.A. & Canada)
	507513007	Machine socket (unit)(Australia, U.K. & Continental Europe)
8	000103509	Setscrew 4X10
9	751631407	Circuit board case (unit)(U.S.A. & Canada)
	751579004	Circuit board case (unit)(Australia, UK and Continental Europe)
10	751346103	Circuit board case
11	501510202	Printed circuit board B (unit)
12	000149301	Screw 3X8
13	751577002	Power transformer (unit)(U.S.A. & Canada)
	751631304	Power transformer (unit)(Australia, UK and Continental Europe)
14	751347104	Circuit board case cap
15	000161206	Setscrew 3X10(B)
16	000115607	Setscrew TP 4X8
17	507654001	Motor (unit)(U.S.A. & Canada)
	751673102	Motor (unit)(Australia, UK and Continental Europe)
18	000115504	Setscrew TP 5X10
19	000053008	Cord binder

PARTSLIST

1

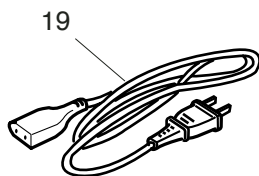
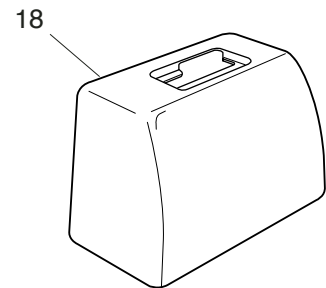
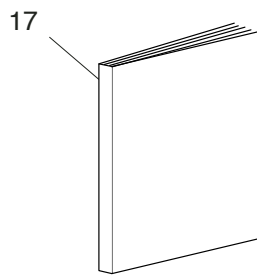
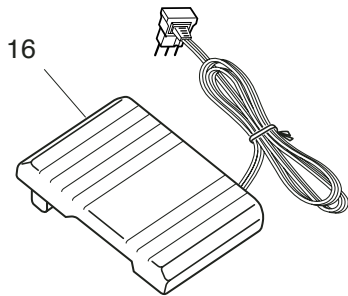
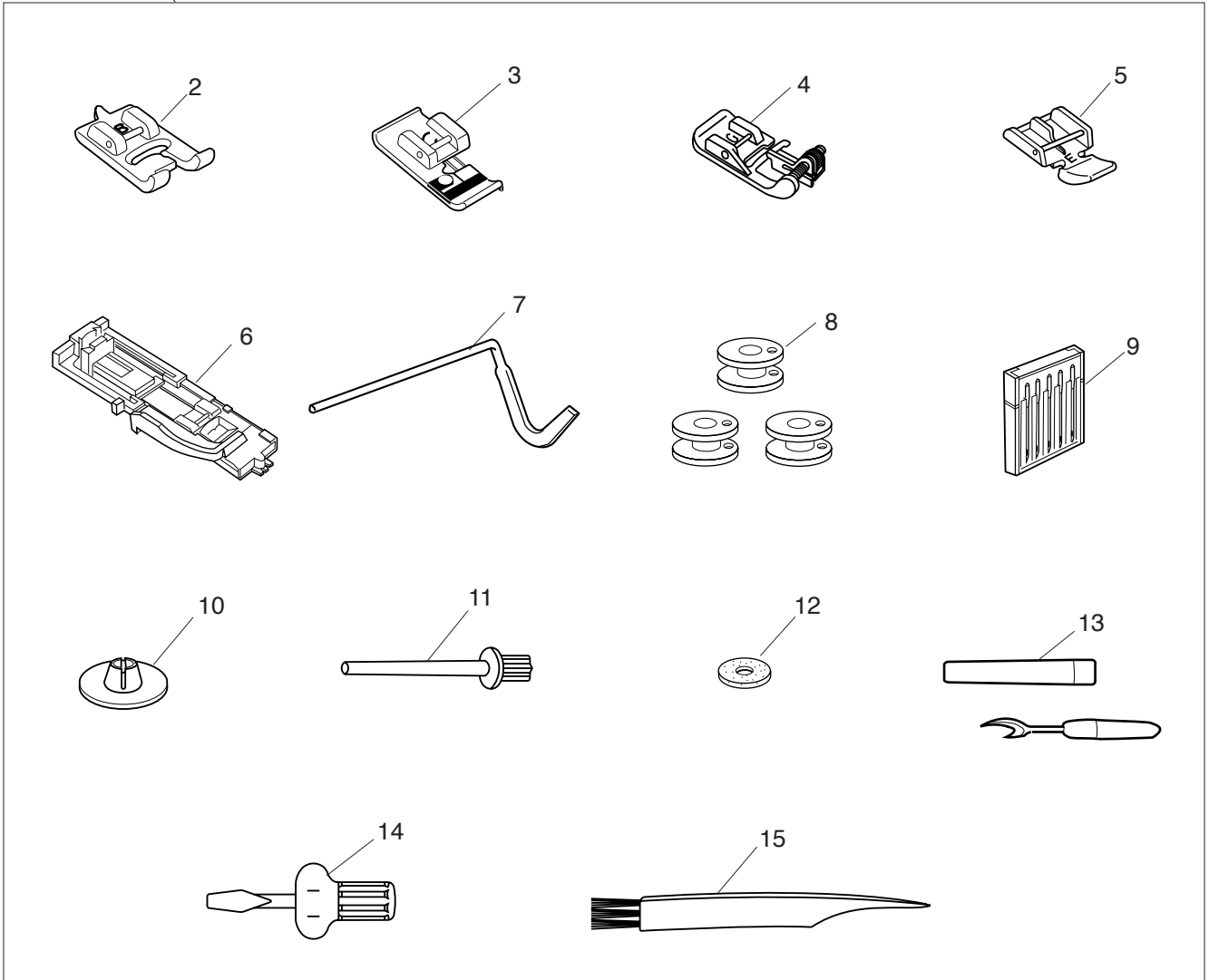

PARTSLIST

No.	Part #	Description
1	507874009	Standard accessories (unit)
2	820801016	BH foot (unit)
3	822801001	Overedge foot (unit)
4	820817015	Blind hem foot (unit)
5	829801002	Zipper foot (unit)
6	753801004	BH foot (unit)
7	802422002	Quilting bar
8	102261000	Bobbin
9	540401026	Needle case (unit)
10	822019509	Spool holder (small)
11	625031500	Additional spool pin (2)
12	102403109	Felt
13	647808009	Seam ripper (buttonhole opener) (unit)
14	820832005	Screwdriver (large)
15	802424004	Lint brush
16	033071222	Foot control (unit)
17	507800347	Instruction book(English)
	507800358	Instruction book(German, Dutch & French)
18	479713205	Cover
19	653524007	Power supply cord(U.S.A. & Canada)
	830314018	Power supply cord(Australia)
	830377008	Power supply cord(UK)
	830335004	Power supply cord(Continental Europe)